

# GE&EL+ vAC/DC ePLUS

## The All-Terrain AC/DC Regenerative Converter

The GE/EL+ vAC/DC is the most complete and versatile converter in the regenerative energy testing market. The whole CINERGIA's catalogue in a single unit. A Grid Emulator (GE), an Electronic Load (EL) and a DC Bidirectional (B2C). This All-Terrain converter is suitable for the majority of test applications in the field of Renewable Energies, Smartgrids, Batteries and Electrical Vehicles.

### Key features



Bidirectional and Regenerative  
Clean grid current: THDi < 3% and PF > 0.98  
Same power in DC and AC

#### Operation Modes:

- Complete DC Load/Source
- Full 4Q AC Grid Emulator
- Power Amplifier for Power HiL
- Full 4Q AC Electronic Load
- Battery Emulation and Testing
- PV Panel Emulation

Modbus/Ethernet Open protocol, Labview drivers

### What's new

#### MASTER/SLAVE CONNECTION

up to 8 units using a fiber optics link to increase power/voltage capabilities:

- GE mode: can be connected in parallel
- EL mode: can be connected in parallel
- B2C: can be connected in parallel, or serial or serial/parallel

#### IMPROVED CONTROL

30kHz closed control loop frequency with 300kHz oversampling technique

#### MORE HARMONICS

50 per phase with 21 free-harmonics, in AC models

#### DELTA LOAD

added to the star connection, for the EL mode in AC

#### SELECTABLE SLEW RATE FOR DC

for the fastest transients and highest stability

#### OPTIMIZED RLC MODE

RMS or instantaneous RLC model for anti-islanding test



ePLUS keeps the robustness, ratings and all the functionalities of the PLUS platform and adds the new features described in this datasheet

### Main Applications

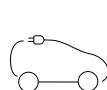

ELECTROMOBILITY

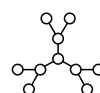

SMARTGRIDS



ANTI-ISLANDING



IEC TESTING



PHOTOVOLTAIC



ACADEMIC & INDUSTRIAL TEST



POWER HiL

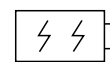

ENERGY STORAGE SYSTEM



# Bidirectional and Regenerative Hardware

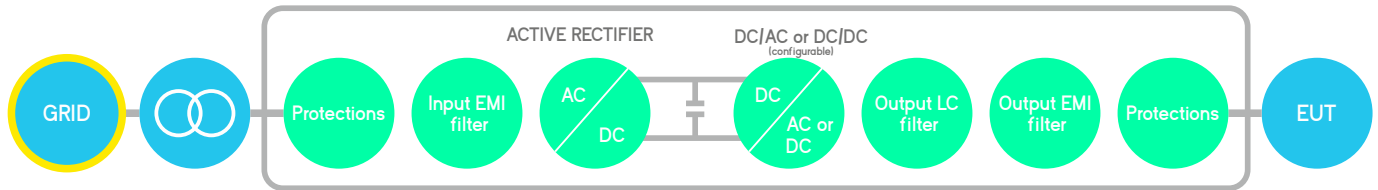

The hardware platform is based on a Back-to-Back power conversion topology, formed by two IGBT-based power stages. The grid side stage is an Active Rectifier which produces clean sinusoidal currents with very low harmonic distortion and power factor close to one.

The EUT side stage can be configured for AC voltage source or AC current source or DC output. In AC, voltage/current are controlled by using state of the art digital Proportional-Resonant controllers. In DC, the three independent buck-boost bidirectional legs enable the separated control of three different DC voltages or currents.

## Block diagram

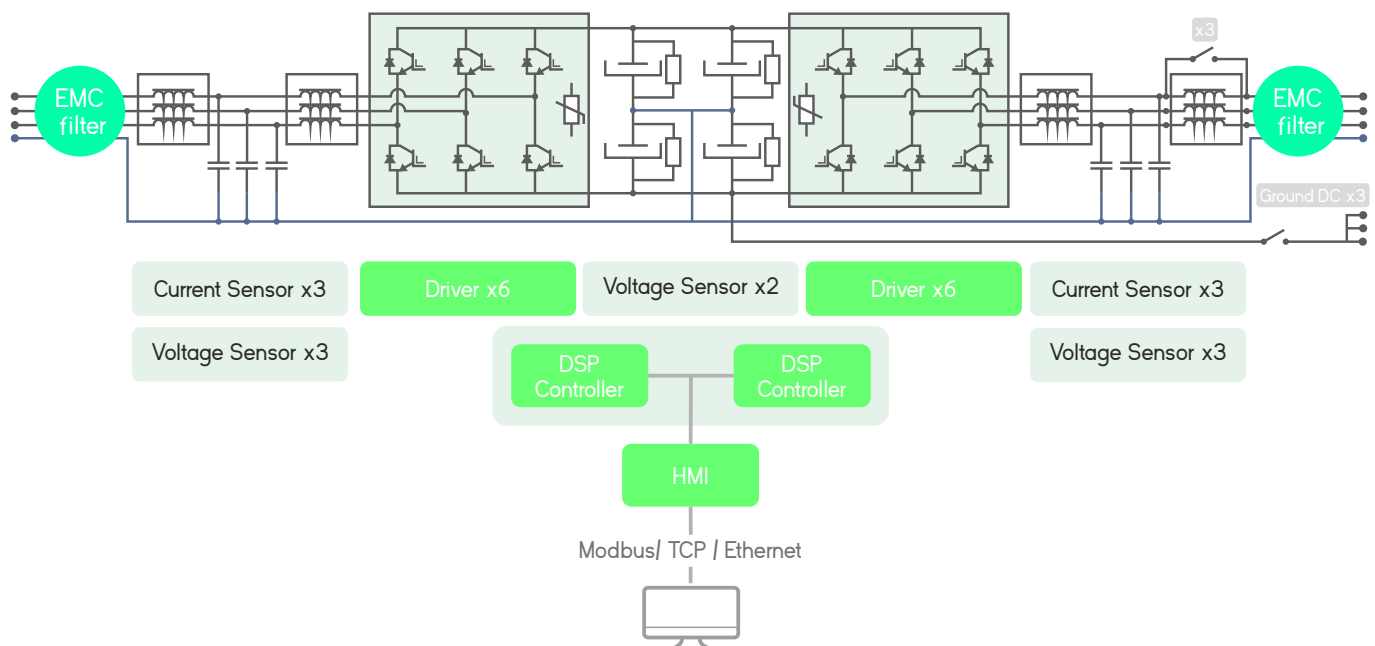

## Local Interface

### Analogue and Digital IO ports

The isolated digital and analogue inputs/outputs permit the connection of the unit to External Controllers and Power Hardware in the Loop systems (option).

### 4.3" Touchscreen

Allows the local parameterization and command of the device, configuration of the communications link, plots the main signals and enables the local datalogging.

### Safety First

The units integrate a local Emergency Stop pushbutton and two signals (input + output) to be connected to the laboratory interlock system. Additionally, the digital outputs can be interfaced to safety tower lights.

### Master/Slave

ePLUS is a modular platform enabling the master/slave connection of units with equal power.



# Software Interface in GE+ and EL+ modes

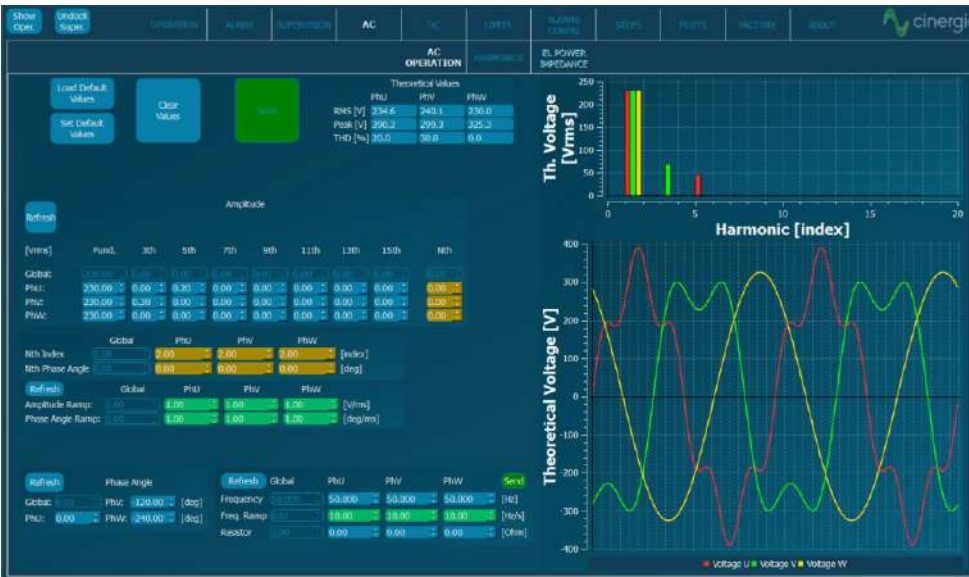

## AC Operation

From this panel, the user can set all AC parameters. Each phase can be independently configured: RMS voltage (GE+) or current (EL+) magnitude, phase delay, harmonics content, free-frequency harmonic and transition ramps. A plot shows the expected real-time waveform, the FFT representation and the numeric data: RMS, peak, CF and THD.

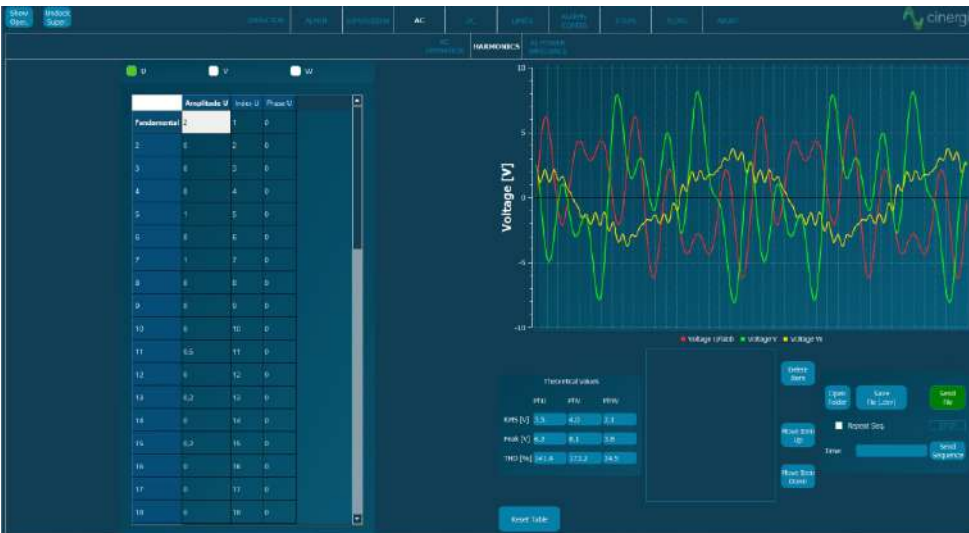

## Harmonics

The device can control simultaneously the magnitude of the first 50 harmonics and 20 free harmonic per phase. These free ones allows the generation of sub-harmonics, inter-harmonics and high frequency harmonics up to the 50th, setting both the magnitude and phase delay.



## Power and Impedance Control

This mode is only available in EL+ configuration. In Power mode, the active and reactive power of each phase is independently controlled. In Impedance mode, the device emulates an RLC load allowing to parameterize resistance, inductance and capacitance per phase making this device suitable for Anti-Islanding test of grid converters.

# Advanced AC Software Applications

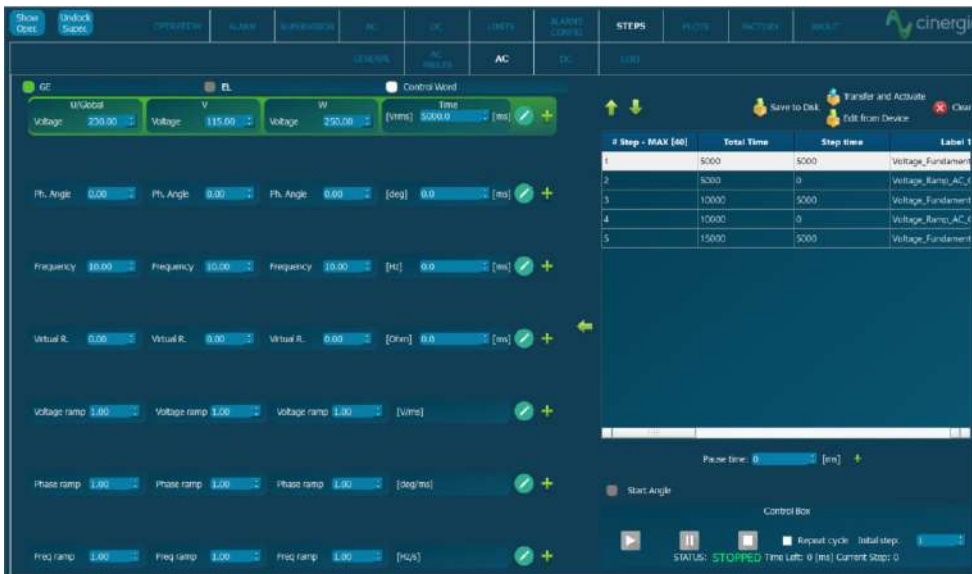

## Steps Mode

One of the most remarkable novelties of the new software is the steps functionality.

Step test files are saved and executed by the DSP allowing deterministic timing with a resolution of 66µs.

The user gains access to all registers of the device to create complex test sequences which run directly in the converter without the need of an external computer.



## Disturbance Generation

The steps mode includes predefined easy-to-use test panels. The AC faults panel is a powerful yet intuitive editor which allows generating and configuring voltage dips, frequency variation, flicker and LVRT. Specific profiles can be saved in .csv files, modified, and reused by importing an existing one. The LVRT page have predetermined profiles for different countries.



## Option IEC Testing

The last version of software includes a library supporting IEC compatible tests. The profiles defined in the standards are preloaded in the software for a user friendly execution and edition. Currently the following standards are available:

- IEC61000-4/11
- IEC61000-4/13
- IEC61000-4/14
- IEC61000-4/28



# Software Interface in DC



## DC Operation

This panel allows the user to access all DC setpoints and limits. Thanks to the unique Multichannel feature, each phase can have a different Operation Mode: voltage, current, power, resistance and advanced DC applications. Transition ramps, voltage and current limits can be modified. The limits for sink and source operation are different for safer testing, specially in battery applications.

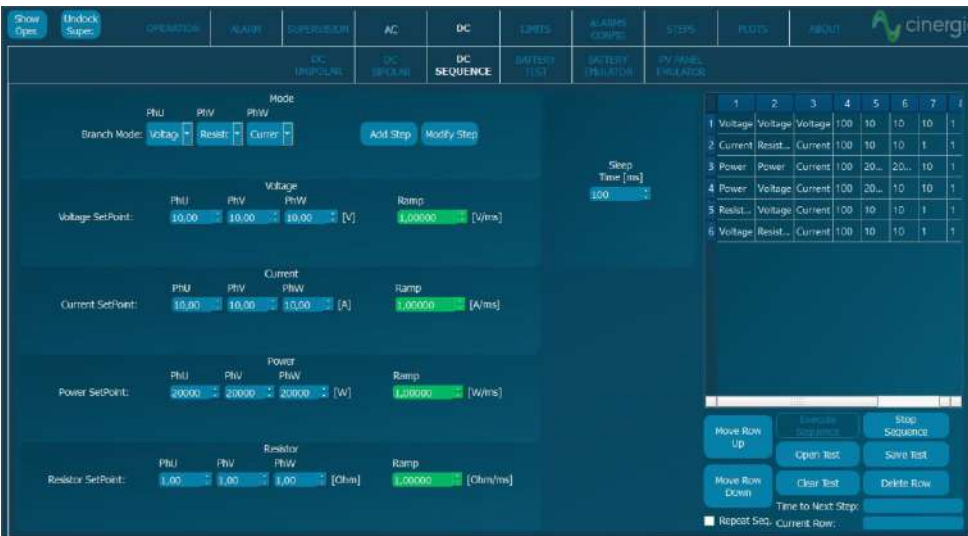

## Sequence

The User Interface Software integrates a Sequence Editor to create automatic test sequences, save them for future use and import them in .csv files.

A smart datalogger can be activated from the LCD of the unit to record automatically the resulting voltage and current measurements with a time resolution of 400 ms.



## Multichannel

Enabling the Separated Channel Control converts the device in three functionally independent DC Bidirectional Power Supplies, sharing the common negative rail. Each channel can have a different status (ON, OFF, Warning, Alarm), Operation Mode (see Range and Specifications table), Setpoint, Ramp and Limits.

# Advanced DC Applications



## Battery Pack Testing

This functionality enables the user to precisely control the charge, discharge and cycling of a Battery. Basic parameters include the charge/discharge current, fast charge and floating voltages while Advanced parameters add Energy (Ah) and Time as transition conditions. Profiles for each Battery technology can be saved and imported in .CSV files.



## Battery Emulation

The B2C+ integrates a mathematical model to emulate the voltage behaviour of a real battery pack. The output voltage will change as a function of the SOC and Current. By configuring the provided parameters, the voltage profile can be adjusted to match different technologies: Lilon, NiMH, NiCd, Pb, Flux, etc.

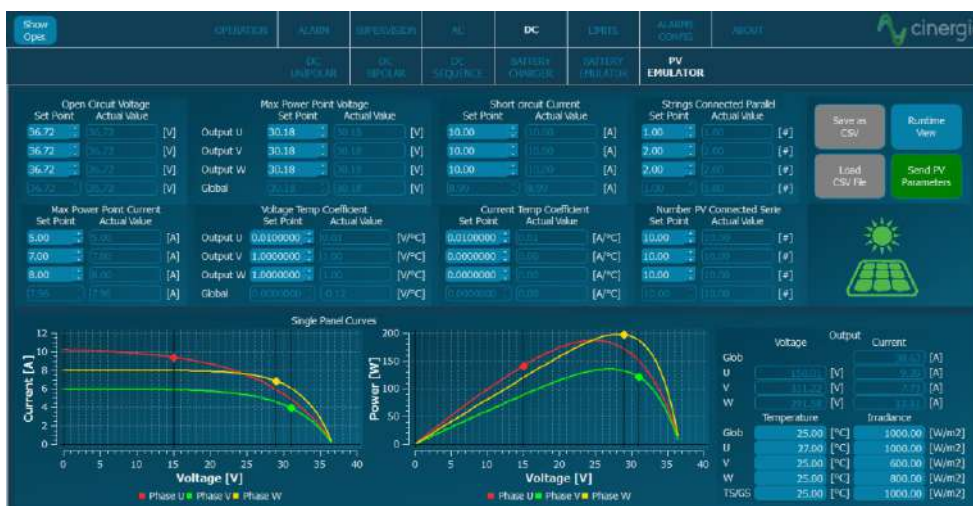

## PV Panel Emulation

The PV Panel model is based on the single-diode equivalent circuit of a PV cell and the series-parallel connection of cells to form a panel. A Runtime functionality allows the simulation of a complete day by launching different irradiance and temperature setpoints from a .csv file, enabling the user burn-in and functional tests of PV Inverters.

# GE&EL+ vAC/DC Range & Specifications

---

## Input side (GRID side)

### AC Voltage

Rated: 3x400Vrms + Neutral + Earth

Range: +15% / -20%

### Rated AC Current

Depends on model (see Wiring Manual)

### Frequency

48-62Hz

### Current Harmonic Distortion

THDi < 3% at rated power

### Current Power factor

PF > 0.98 at rated power

### Efficiency

≥ 89% (7.5 & 10), ≥ 91% (15 to 30), ≥ 92% (40 to 200)

---

## Output side in DC (EUT side)

### Terminals

Number: 6 (3 positive + 3 negative)

### Configuration of Channels

Unipolar 3-channels 2Q, independent setpoints per channel

Unipolar 1-channel 2Q, one global setpoint for all channels

Multichannel: 2Q, independent start/stop, operation mode and setpoints per channel (note: multichannel is an option for ≥ 80kVA)

Bipolar (4Q two independent setpoints)

### Voltage Mode (CV)

Range: 2Q: 20<sup>(1)</sup> to 750V (800V with High Voltage option)

4Q: 0 to +350V / 0 to -350 (+ rail / 0 / - rail, Bipolar configuration)

Setpoint Resolution: 10mV

Effective Resolution<sup>(2)</sup>: < 0.05% of FS<sup>(3)</sup>

Setpoint Accuracy<sup>(4)</sup>: ± 0.1% of FS<sup>(3)</sup>

Transient Time<sup>(5)</sup>: < 1ms (10% to 90% at a step to Vrated)

Ripple<sup>(7)</sup> (peak-peak): < 0.55% of FS<sup>(3)</sup>

### Current Mode (CC)

Range: from 0 to ± 110% of Irated (see models table)

Setpoint Resolution: 10mA

Effective Resolution<sup>(2)</sup>: < 0.05% of FS<sup>(3)</sup> (< 0.1% models 7.5 & 10)

Setpoint Accuracy<sup>(4)</sup>: ± 0.2% of FS<sup>(3)</sup>

Transient Time<sup>(5)</sup>: < 1ms (10% to 90% at a step to Irated)

Ripple<sup>(7)</sup> (peak-peak): < 0.7% of FS<sup>(3)</sup>

### Power Mode (CP)

Range: from 0 to ± 200%<sup>(8)</sup> of Prated (see models table)

Derived current setpoint: Psetpoint / Vmeasured

Setpoint Resolution: 1W

Effective Resolution<sup>(2)</sup>: < 0.1% of FS<sup>(3)</sup> (< 0.25% models 7.5 & 10)

Setpoint Accuracy<sup>(4)</sup>: ± 0.4% of FS<sup>(3)</sup>

Transient Time<sup>(5)</sup>: < 2.5ms (10% to 90% at a step to Prated)

### Resistance Mode (CR)

Range: from 0.1 to 1000 Ohm

Derived current: Vmeasured / Rsetpoint

Setpoint Resolution: 0.01 Ohm

Setpoint Accuracy<sup>(4)</sup>: ± 0.2% of FS<sup>(3)</sup>

Transient Time<sup>(5)</sup>: < 2ms (10% to 90% at a step to Rrated))

---

---

## Output side in AC (EUT side)

### Terminals

Number: 4 (3 phases + 1 neutral)

### Configuration of Channels

3-channels: 4Q, independent setpoints per phase

1-channel: 4Q, global setpoints for all phases (only in GE+)

Multichannel: 4Q, independent start/stop, alarm status and setpoints per phase (note: multichannel is an option for  $\geq 80\text{kVA}$ )

---

## Output side in GE-AC

### Voltage Mode (CV)

Peak:  $\pm 400\text{V}$  phase-neutral

Range:  $0^{(1)}$  to  $277\text{Vrms}$  phase-neutral ( $295\text{Vrms}$  with HV option)

$0^{(1)}$  to  $480\text{Vrms}$  phase-phase ( $510\text{Vrms}$  with HV option)

THDv:  $< 0.1\%$  rated linear load at  $230\text{Vrms}$ , 50/60Hz

$< 0.9\%$  rated non linear load  $\text{CF}=3$  at  $230\text{Vrms}$ , 50/60Hz

Setpoint Resolution:  $10\text{mVrms}$

Effective Resolution<sup>(2)</sup>:  $< 0.05\%$  of  $\text{FS}^{(3)}$

Setpoint Accuracy<sup>(4)</sup>:  $< \pm 0.1\%$  of  $\text{FS}^{(3)}$

Transient Time<sup>(5)</sup>:  $< 1.5\text{ms}$  (10% to 90% at a step to  $V_{\text{rated}}$ )

Ripple<sup>(7)</sup>(peak-peak):  $< 0.55\%$  of  $\text{FS}^{(3)}$

### Enhanced Harmonics

Range: up to 50th (at 50/60 Hz fundamental)

50 independent harmonics per phase:

20 free programmable frequency and phase from 0.1 to 50 times  $f_0$

30 fixed frequency

Harmonics content:  $V \cdot f < 46000$  (with current derating)

Setpoint Accuracy<sup>(4)</sup>: same as voltage accuracy

Small Signal Bandwidth: up to  $5000\text{Hz}^{(9)}$

Transient Time<sup>(5)</sup>:  $< 2\text{ms}$  (10% to 90% at a step change)

### Frequency

Fundamental Frequency Range: 10 to  $100\text{Hz}$  (up to  $400\text{Hz}$  option)

Small Signal Bandwidth: up to  $5000\text{Hz}^{(9)}$

Resolution:  $1\text{mHz}$

### Phase Angle

Range: 0 to  $360^\circ$

Resolution:  $0.01^\circ$

---



## Output side in EL-AC

### Admissible Voltage

Connection: 1-phase, 3-phase star or 3-phase delta

Maximum:  $\pm 400\text{V}$  peak

Range: 10-100Hz

35<sup>(1)</sup> to 277Vrms phase-neutral (295Vrms with HV option)

35<sup>(1)</sup> to 480Vrms phase-phase (510Vrms with HV option)

> 100Hz: maximum rms voltage follows  $V \cdot f < 46000$

Frequency: 10 to 400Hz

### Current Mode (CC)

Range: from 0 to  $\pm 200\%$ <sup>(8)</sup> of Irated (see models table)

Setpoint Resolution: 10mArms

Effective Resolution<sup>(2)</sup>:  $< 0.05\%$  of FS<sup>(3)</sup> ( $< 0.1\%$  models 7.5 & 10)

Setpoint Accuracy<sup>(4)</sup>:  $< \pm 0.2\%$  of FS<sup>(3)</sup>

Transient Time<sup>(5)</sup>:  $< 1.5\text{ms}$  (10% to 90% at a step transient)

Ripple<sup>(7)</sup> (peak-peak):  $< 0.7\%$  of FS<sup>(3)</sup> (with Low Ripple Inductor option)

### Phase Angle (cos $\phi$ )

Range:  $-90$  to  $90^\circ$  in Sink / Source

Resolution:  $0.01^\circ$

### Enhanced Harmonics

Range: up to 50th

50 independent harmonics per phase:

20 free programmable frequency and phase from 0.1 to 50 times  $f_0$

30 fixed frequency

Harmonics content:  $V \cdot f < 46000$  (with current derating)

Setpoint Accuracy<sup>(4)</sup>: same as current accuracy

Small Signal Bandwidth: up to 5000Hz<sup>(9)</sup>

Transient Time<sup>(5)</sup>:  $< 2\text{ms}$  (10% to 90% at a step change)

### Power Mode (CP / CS)

Range: from 0 to  $\pm 200\%$ <sup>(8)</sup> of Prated (see models table)

Derived current setpoint: calculated from  $|S|$  and  $\Phi(S)$

Setpoint Resolution: 1W, 1VA

Effective Resolution<sup>(2)</sup>:  $< 0.1\%$  of FS<sup>(3)</sup> ( $< 0.25\%$  models 7.5 & 10)

Setpoint Accuracy<sup>(4)</sup>:  $\pm 0.4\%$  of FS<sup>(3)</sup>

Transient Time<sup>(5)</sup>:  $< 2.5\text{ms}$  (10% to 90% at a step to Prated)

### Impedance Mode (CZ)

Enhanced Calculation method configurable (rms, instantaneous)

Range: from 0.8 to 1000 Ohm, 0.1 to 2000mH, 0 to 3.7mF

Derived current/phase setpoint: calculated from  $|Z|$  and  $\Phi(Z)$

Setpoint Resolution: 0.01 Ohm/mH/mF

Setpoint Accuracy<sup>(4)</sup>: see current accuracy

Transient Time<sup>(5)</sup>:  $< 2.5\text{ms}$  (10% to 90% at a step to Rrated)

---

## Operation Modes

### DC

Programmable Voltage (CV)  
Programmable Current (CC)  
Programmable Power (CP)  
Programmable Resistance (CR)  
Power Amplifier (HiL)  
Steps  
**Optional** Battery Testing (BTest)(charge/discharge/cycling)  
**Optional** Battery Emulation (Bemu)  
**Optional** PV Panel Emulation (PVEmu)

### AC

Programmable Voltage (CV)(only in GE+)  
Programmable Current (CC)(only in EL+)  
Programmable Power (CP / CS)(only in EL+)  
Programmable Impedance (CZ)(only in EL+)  
Power Amplifier (HiL)  
Steps  
**Optional** LVRT, IEC 61000 -4-11, 4-13, 4-14, 4-28

---

## Overload/Overcurrent

Admissible DC overcurrent is: 110% of rated value during 1 minute  
Admissible AC overcurrent: 125% of rated value during 10 minutes,  
150% during 1 minute, 200% during 2 seconds  
Admissible overloads: 125% of rated value during 10 minutes,  
150% during 1 minute, 200% during 2 seconds

---

## User Interface

### Local Control (4.3" Touchscreen panel)

Isolated Digital port: 6 inputs, 4 outputs  
Isolated Analogue port: 6 inputs (rms setpoints or power amplifier),  
6 outputs (rms readback or real-time readback)  
Interlock port: 1 NC Input, 1 NO Output  
Emergency Stop pushbutton

### Remote Control Port

LAN Ethernet with Open Modbus-TCP protocol  
RS485 (option), CAN and RS232 (using external gateway)

### Software

Graphical User Interface for Windows 7/10  
LabView drivers and open Labview interface example

**Enhanced**

### Master/Slave operation

Connection: fiber optics link (x6)  
Configuration: from software user interface/MODBUS  
up to 8 units:  
AC: parallel  
DC: parallel, serial or serial-parallel



---

## Protections

Overvoltage (peak, rms), Overcurrent (peak, rms), Overload  
Shortcircuit, Emergency Stop, Watchdog, Heart Beat, Output  
Contactor, Wrong Configuration  
Alarms and Limits are user configurable and can be saved in a  
password protected EEPROM

---

## Mesurements<sup>(6)</sup>

Grid Voltage (rms), Current (rms), Power (P,Q) and Frequency  
Output Voltage (rms, avg), Current (rms, avg), Power (P,Q) and  
Frequency  
Heatsink Temperatures (x2) and DC Link Voltage  
Datalogging available through FTP connection

---

## Ambient

Operating temperature<sup>(8)</sup>: 5-40°C  
Relative Humidity: up to 95%, non-condensing  
Cooling: Forced air  
Acoustic noise at 1m: < 52dB(A)(7.5 to 60), < 65dB(A)(80 to 120), < 70dB(A)(160 and 200)

---

## Standards

CE Marking  
Operation and Safety: EN-50178, EN-62040-1  
EMC: EN-62040-2  
RoHS

---

All specifications are subject to change without notice.

# Options

Choose your options

- Galvanic Isolation
- Multichannel mode: allows different operation mode, start/stop/reset per channel (included in all models from 7.5 to 60, both included)
- 30kHz Switching Frequency: only available for models 15 (derated to 7.5kW), 20 (derated to 7.5kW) and 30 (derated to 10kW)
- Isolation monitor (advised for IT systems)
- Low voltage ripple capacitance
- Low current ripple inductance (included in all models ≤54kW, optional for models ≥80kW)
- High Frequency 360 - 900 Hz
- Anti-islanding monitor (only advised in net injection to the grid and following local regulations)
- High Voltage (HV): voltage up to 295Vrms phase-neutral in AC up to 800V in DC
- RS485
- Battery Emulation
- Battery Test
- PV Panel Emulation
- Predefined Tests: LVRT, IEC 61000-4-11, 4-13, 4-14, 4-28 (consult us for specific Test)
- External gateway for RS232, CAN and others (consult us for specific gateway)

---

All specifications are subject to change without notice.

(1) Minimum voltage setpoint is 0V in DC. The recommended minimum setpoint for long-term use is 20Vrms in AC and 20V in DC.  
(2) Effective resolution measured with a 400ms window  
(3) FS Range of voltage is 800V (with High Voltage option)  
FS Range of current is 2|3 · I<sub>rated</sub> |(see models table)  
FS Range of power is 2|200% · Prated |(see models table)

(4) Accuracies are valid for settings above 10% of FS  
(5) Measured with the rated resistive load and high-dynamics controllers configuration  
(6) Accuracy of measurements is ±0.1% of FS for rms voltage, ±0.2% of FS for rms current, ±0.4% of FS for active power (valid only above 10% of FS)  
(7) Consult us for lower voltage/current ripple requirements  
(8) Rated power figures are given at 20°C  
(9) The maximum output voltage depends on frequency following V·f < 46000

# Models

## GE&EL+ vAC/DC

Reference	AC Power Rated (9)	DC Power Rated (9)	AC Current Rated (9) RMS 3 channels / 1 channel	DC Current Rated (9) RMS 3 channels / 1 channel	Weight (kg)	Dimensions DxWxH (mm)
GE&EL+7.5 vAC/DC	7.5kW	7.5kW	11A / 33A	±10A / ±30A	155 kg	770x450x1100 mm
GE&EL+10 vAC/DC	10kW	10kW	15A / 45A	±15A / ±45A	155 kg	770x450x1100 mm
GE&EL+15 vAC/DC	15kW	15kW	22A / 66A	±20A / ±60A	155 kg	770x450x1100 mm
GE&EL+20 vAC/DC	20kW	20kW	29A / 87A	±25A / ±75A	155 kg	770x450x1100 mm
GE&EL+30 vAC/DC	27kW	27kW	40A / 120A	±30A / ±90A	155 kg	770x450x1100 mm
GE&EL+40 vAC/DC	40kW	40kW	58A / 174A	±40A / ±120A	190kg	770x450x1100 mm
GE&EL+50 vAC/DC	50kW	50kW	73A / 219A	±50A / ±150A	190kg	770x450x1100 mm
GE&EL+60 vAC/DC	54kW	54kW	80A / 240A	±57A / ±171A	190kg	770x450x1100 mm
GE&EL+80 vAC/DC	80kW	80kW	116A / -	±105A / ±315A	270kg	880x875x1320 mm
GE&EL+100 vAC/DC	100kW	100kW	145A / -	±130A / ±390A	295kg	880x875x1320 mm
GE&EL+120 vAC/DC	108kW	108kW	157A / -	±130A / ±390A	295kg	880x875x1320 mm
GE&EL+160 vAC/DC	145kW	145kW	211A / -	±155A / ±465A	545kg	850x900x2000 mm
GE&EL+200 vAC/DC	160kW	160kW	232A / -	±185A / ±555A	555kg	850x900x2000 mm

All specifications are subject to change without notice.

## Galvanic Isolation (optional)

	Circuit Breaker Recommended	Weight (kg)	Circuit Breaker Recommended	Weight (kg)	Dimensions DxWxH (mm)			
INSIDE THE CABINET	IT 7.5i	Type C - 25A	145 kg	IN EXTERNAL CABINET IP20	IT 30e	Type D - 80A	174 kg	595x415x708 mm
	IT 10i	Type C - 25A	145 kg		IT 40e	Type D - 100A	217 kg	725x525x773 mm
	IT 15i	Type C - 32A	145 kg		IT 50e	Type D - 125A	280 kg	725x525x773 mm
	IT 20i	Type C - 40A	145 kg		IT 60e	Type D - 160A	381 kg	875x600x900 mm
	IT 30i	Type C - 50A	195 kg		IT 80e	Type D - 200A	435 kg	875x600x900 mm
	* IT 40i	Type C - 63A	195 kg		IT 100e	Type D - 250A	458 kg	875x600x900 mm
	* IT 50i	Type C - 83A	195 kg		IT 120e	Type D - 315A	514 kg	875x600x900 mm
					IT 160e	Type D - 400A	612 kg	964x684x1252 mm
					IT 200e	Type D - 500A	753 kg	1192x744x1430 mm

\* In the IT40i and IT50i models the size of the cabinet increases to a total of 770x835x1100mm. The others keep the original size.

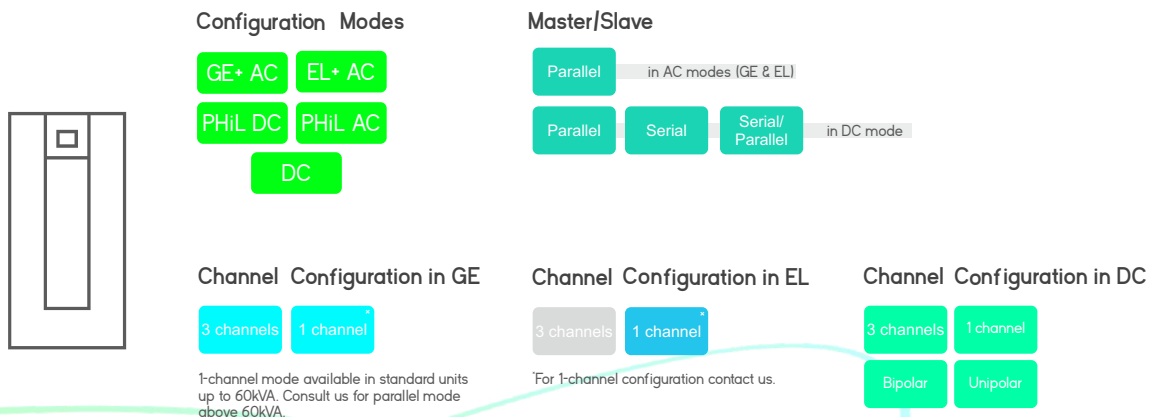

## CINERGIA, Regenerative Power Electronics Solutions

- Grid Emulators AC, DC, AC/DC
- Electronic Loads, AC, DC, AC/DC, HF (360-900Hz)
- Bidireccional DC, Battery Emulators, PV Panel Emulators

Can Baletes, 7 Nau A (Poligon el Cros)  
08310, Argentona, BARCELONA  
cinergia.coop  
cinergia@cinergia.coop