

B2C+ ePlus

Regenerative DC Converter



B2C+ is CINERGIA's solution for Regenerative and Bidirectional DC Test Platforms. Thanks to its unique flexibility, it can be used in multiple applications: Renewable Energy Sources, Energy Storage Systems, Battery Testing and Characterization, Electrical Vehicles, EV Charging Infrastructure, Traction Converters and Avionics.



Regenerative Technology

Thanks to our bi-directional topology, the B2C+ Bidirectional DC Converter are regenerative, resulting in a reduction of both the consumed energy during the tests and the power required from the electrical installation.

This technology allows us to work in both directions, as power generators or offering a consumption for the realization of all types of tests.

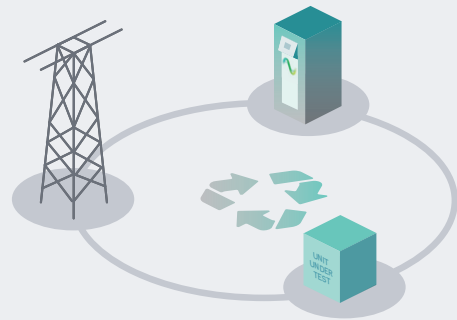

Main Applications



Electromobility



Smart Grids

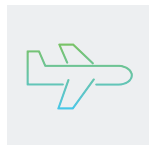

Avionics



IEC Testing

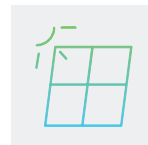

Photovoltaic



Power HiL

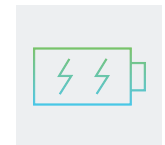

Energy Storage System

Bidirectional and Regenerative

Clean grid current

THDi <3% and PF > 0.98

2 Quadrants and 4 Quadrants Configuration

13 Models

from 7.5kW to 160kW

Voltage Range

up to 800V and 1500V

Parallelization of units to increase the power

Overload of 200% P_{rated}

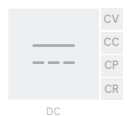
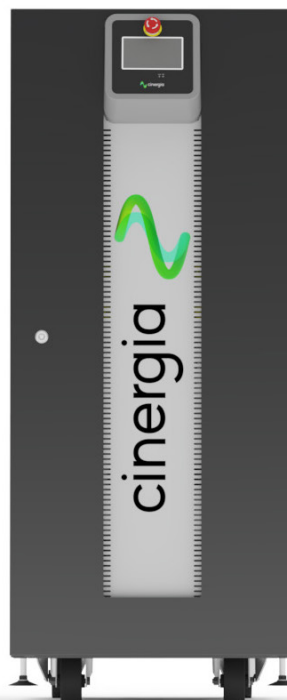

Battery Pack Testing (included)

Battery Emulation (option)

PV Panel Emulation (option)

Automated Test profiles (csv file)

Power Amplifier Mode for PHiL applications

Modbus/Ethernet Open protocol, Labview drivers

The most versatile product

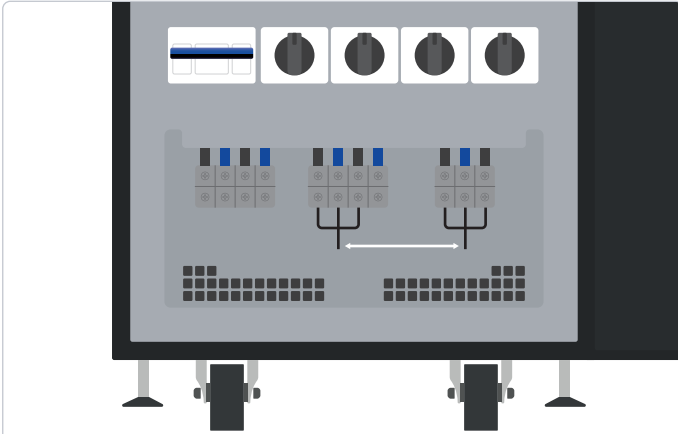

1 Channel with 3 times current

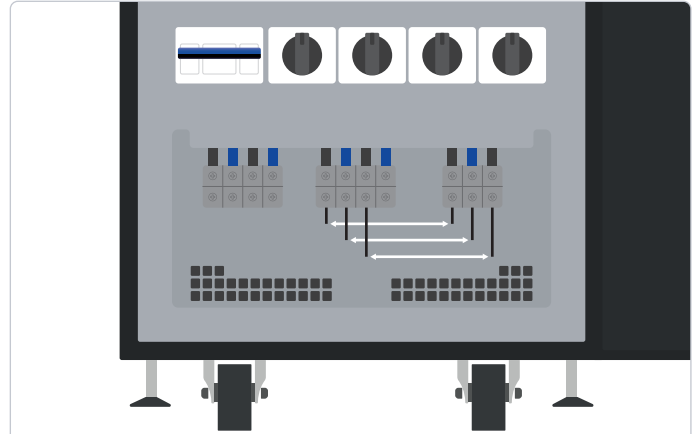

3 Channels Independent

Three different Master/Slave connection possibilities

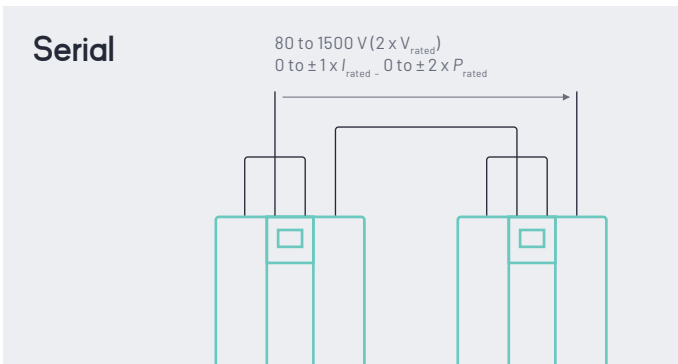

Up to

1500 V

Thanks to its new technology in device parallelization, our equipments can carry out high-power projects.

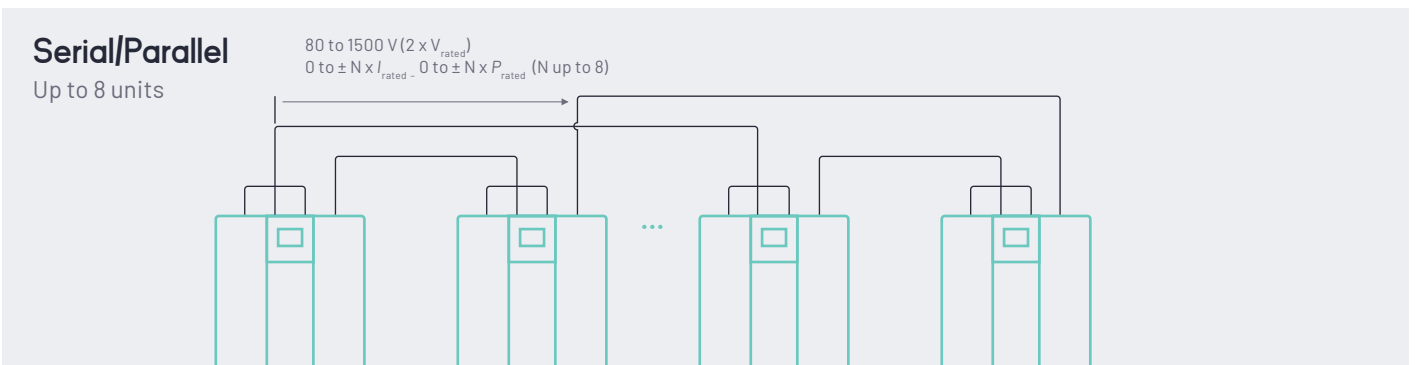

Bidirectional and Regenerative Hardware

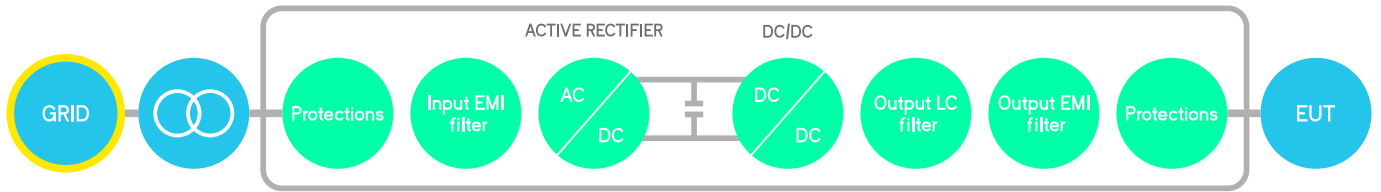

The hardware platform is based on a Back-to-Back power conversion topology, formed by two IGBT-based power stages. The grid side stage is an Active Rectifier which produces clean sinusoidal currents with very low harmonic distortion and power factor close to one.

The EUT side stage can be configured for AC voltage source or AC current source or DC output. In AC, voltage/current are controlled by using state of the art digital Proportional-Resonant controllers. In DC, the three independent buck-boost bidirectional legs enable the separated control of three different DC voltages or currents.

Block Diagram

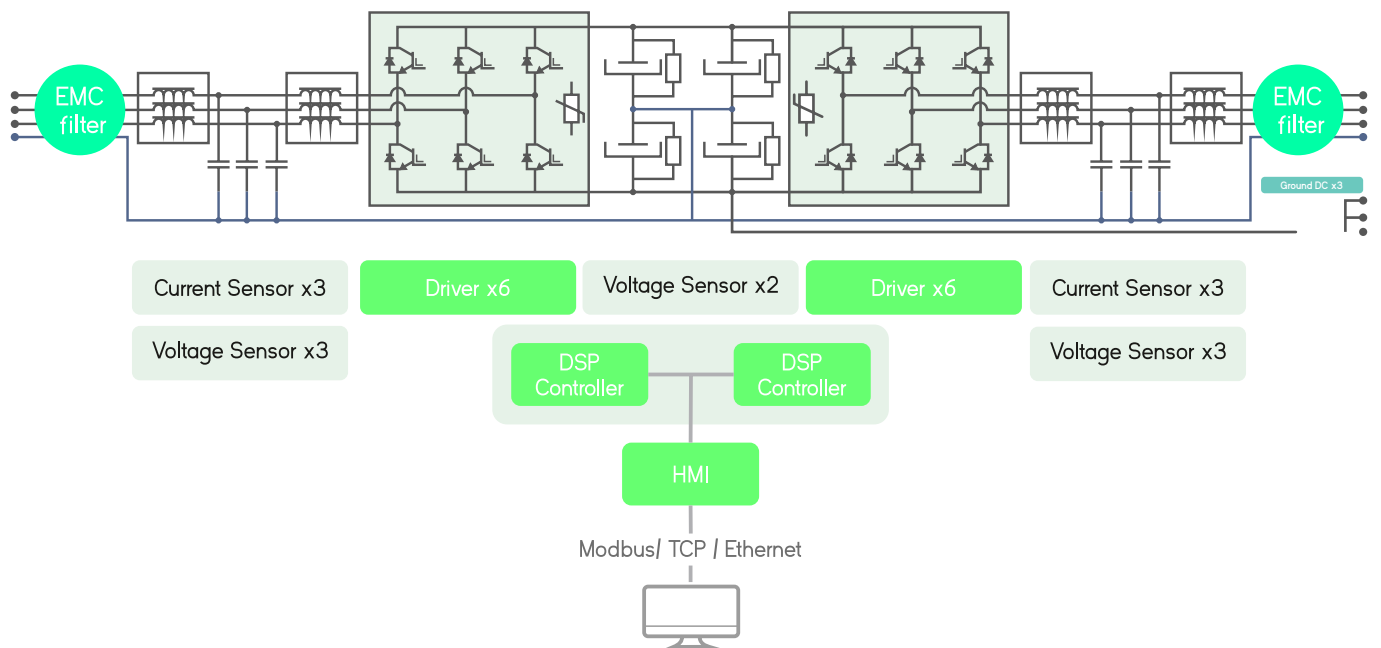

Local Interface

Analogue and Digital IO ports

The isolated digital and analogue inputs/outputs permit the connection of the unit to External Controllers and Power Hardware in the Loop systems (option).

4.3" Touchscreen

Allows the local parameterization and command of the device, configuration of the communications link, plots the main signals and enables the local datalogging.

Safety First

The units integrate a local Emergency Stop pushbutton and two signals (input+ output) to be connected to the laboratory interlock system. Additionally, the digital outputs can be interfaced to safety tower lights.

Master/Slave

ePLUS is a modular platform enabling the master/slave connection of units with equal power.



Software



The user interface used by CINERGIA devices has been developed by our R&D team, to offer total control of the device, with a comfortable and intuitive design. This allows us to take full advantage of the capabilities of the device, as well as the programming and execution of standardized or self-created tests.

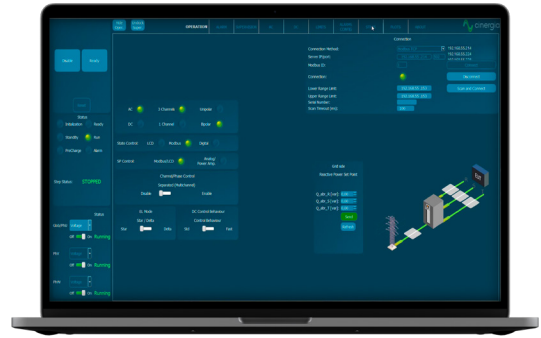

DC



DC Operation

This panel allows the user to access all DC setpoints and limits. Thanks to the unique Multichannel feature, each phase can have a different Operation Mode: voltage, current, power, resistance and advanced DC applications. Transition ramps, voltage and current limits can be modified. The limits for sink and source operation are different for safer testing, specially in battery applications.



Sequence

The User Interface Software integrates a Sequence Editor to create automatic test sequences, save them for future use and import them in .csv files. A smart datalogger can be activated from the LCD of the unit to record automatically the resulting voltage and current measurements with a time resolution of 400 ms.

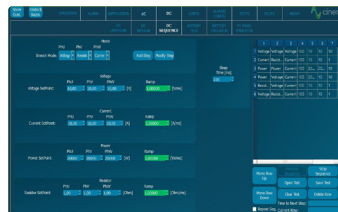

Multichannel

Enabling the Separated Channel Control converts the device in three functionally independent DC Bidirectional Power Supplies, sharing the common negative rail. Each channel can have a different status (ON, OFF, Warning, Alarm), Operation Mode (see Range and Specifications table), Setpoint, Ramp and Limits.



Battery Pack Tester

This functionality enables the user to precisely control the charge, discharge and cycling of a Battery. Basic parameters include the charge/discharge current, fast charge and floating voltages while Advanced parameters add Energy (Ah) and Time as transition conditions. Profiles for each Battery technology can be saved and imported in .CSV files.

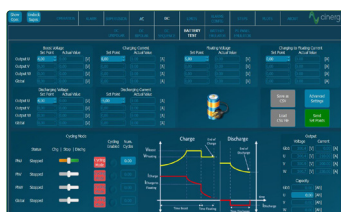

Battery Emulation

The B2C+ integrates a mathematical model to emulate the voltage behaviour of a real battery pack. The output voltage will change as a function of the SOC and Current. By configuring the provided parameters, the voltage profile can be adjusted to match different technologies: Lilon, NiMH, NiCd, Pb, Flux, etc.

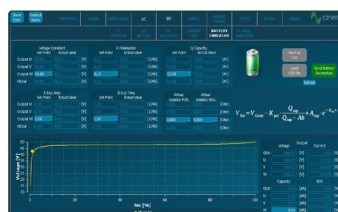

PV Panel Emulation

The PV Panel model is based on the single-diode equivalent circuit of a PV cell and the series-parallel connection of cells to form a panel. A Runtime functionality allows the simulation of a complete day by launching different irradiance and temperature setpoints from a .csv file, enabling the user burn-in and functional tests of PV Inverters.



B2C+ Range & Specifications

Input side (GRID side)

AC Voltage

Rated: 3x400Vrms +Neutral+ Earth
Range: +15% / -20% (-10% @ P_{rated})

Rated AC Current

Depends on model (see Wiring Manual)

Frequency

48-62Hz

Current Harmonic Distortion

THDi < 3% at rated power

Current Power Factor

PF > 0.98 at rated power

Efficiency

≥ 89% (7.5 & 10), ≥ 91% (15 to 30), ≥ 92% (40 to 200)

Output side in DC (EUT side)

Terminals

Number: 6 (3 positive + 3 negative)

Configuration of Channels

Unipolar 3-channels 2Q, independent setpoints per channel

Unipolar 1-channel 2Q, one global setpoint for all channels

Multichannel: 2Q, independent start/stop, operation mode and setpoints per channel

Bipolar (4Q two independent setpoints)

Voltage (CV)

Range: 2Q: 20⁽¹⁾ to 800V

4Q: 0 to +350V / 0 to -350 (+ rail / 0 / - rail, Bipolar configuration)

Setpoint Resolution: 10mV

Effective Resolution⁽²⁾: < 0.05% of FS⁽³⁾

Setpoint Accuracy⁽⁴⁾: ± 0.1% of FS⁽³⁾

Transient Time⁽⁵⁾: < 1ms (10% to 90% at a step to V_{rated})⁽¹⁰⁾

Ripple⁽⁷⁾ (peak-peak): < 0.55% of FS⁽³⁾

Current Mode (CC)

Range: from 0 to ± 110% of I_{rated} (see models table)

Setpoint Resolution: 10mA

Effective Resolution⁽²⁾: < 0.05% of FS⁽³⁾ (< 0.1% models 7.5 & 10)

Setpoint Accuracy⁽⁴⁾: ± 0.2% of FS⁽³⁾

Transient Time⁽⁵⁾: < 1ms (10% to 90% at a step to I_{rated})⁽¹⁰⁾

Ripple⁽⁷⁾ (peak-peak): < 0.7% of FS⁽³⁾

Power Mode (CP)

Range: from 0 to ± 200%⁽⁸⁾ of P_{rated} (see models table)

Derived current setpoint: P_{setpoint} / V_{measured}

Setpoint Resolution: 1W

Effective Resolution⁽²⁾: < 0.1% of FS⁽³⁾ (< 0.25% models 7.5 & 10)

Setpoint Accuracy⁽⁴⁾: ± 0.4% of FS⁽³⁾

Transient Time⁽⁵⁾: < 2.5ms (10% to 90% at a step to P_{rated})⁽¹⁰⁾

Resistance Mode (CR)

Range: from 0.1 to 1000 Ohm

Derived current: V_{measured} / R_{setpoint}

Setpoint Resolution: 0.01 Ohm

Setpoint Accuracy⁽⁴⁾: ± 0.2% of FS⁽³⁾

Transient Time⁽⁵⁾: < 2ms (10% to 90% at a step to R_{rated})⁽¹⁰⁾

Operation Modes

DC

Programmable Voltage (CV)

Programmable Current (CC)

Programmable Power (CP)

Programmable Resistance (CR)

Power Amplifier (HiL)

Steps

Battery Testing (BTest) (charge/discharge/cycling)

Optional Battery Emulation (BEmu)

Optional PV Panel Emulation (PVEmu)

Overload/ Overcurrent

Admissible DC overcurrent is: 110% of rated value during 1 minute
 Admissible overloads: 125% of rated value during 10 minutes,
 150% during 1 minute, 200% during 2 seconds

User Interface

Local Control (4.3" Touchscreen panel)

Isolated Digital port: 6 inputs, 4 outputs
 Isolated Analogue port: 6 inputs (rms setpoints or power amplifier), 6 outputs (rms readback or real-time readback)
 Interlock port: 1 NC Input, 1 NO Output
 Emergency Stop pushbutton

Emergency Stop
pushbutton

Touchscreen panel

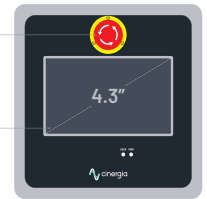

Remote Control Port

LAN Ethernet with Open Modbus-TCP protocol
 RS485 (option), CAN and RS232 (using external gateway)

Software

Graphical User Interface for Windows 7/10
 LabView drivers and open Labview interface example

Enhanced

Master/Slave Operation

Connection: fiber optics link (x6)
 Configuration: from software user interface/MODBUS up to 8 units:
 DC: Parallel, serial or serial-parallel

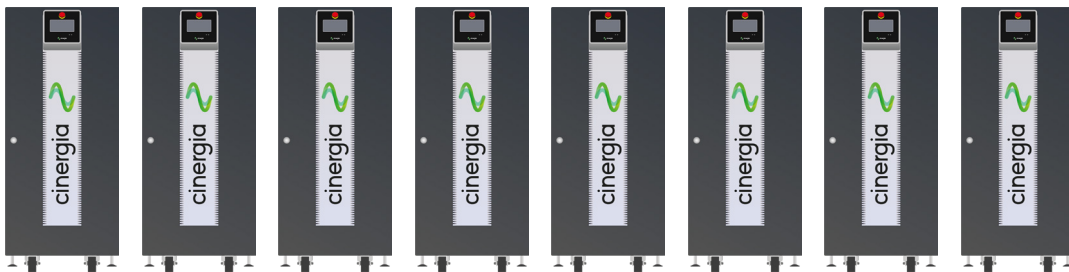

Size and Weight

Models 7.5 to 60 kW

Height

1100 mm

Width

450 mm

Depth

770 mm

Weight

200 kg

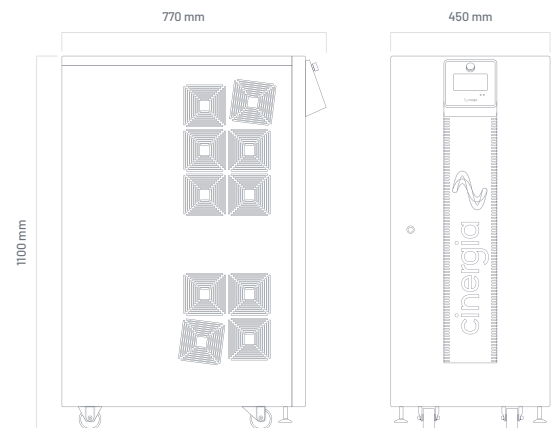

Models 80 to 120 kW

Height

1320 mm

Width

590 mm

Depth

870 mm

Weight

320 kg

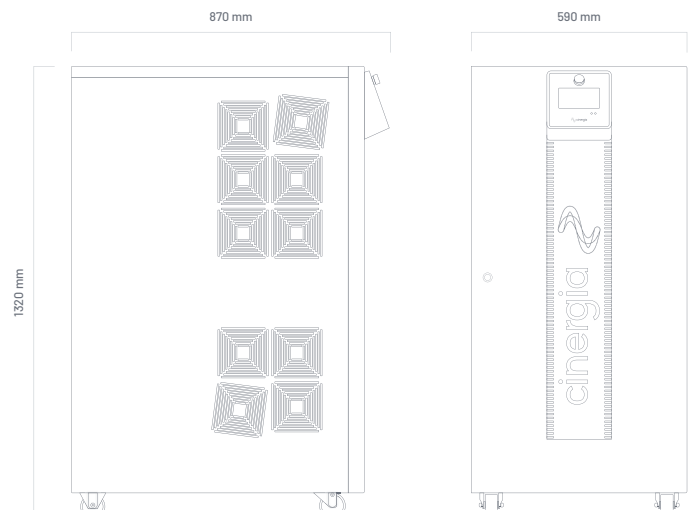

Models 160 & 200 kW

Height

2000 mm

Width

900 mm

Depth

850 mm

Weight

680 kg

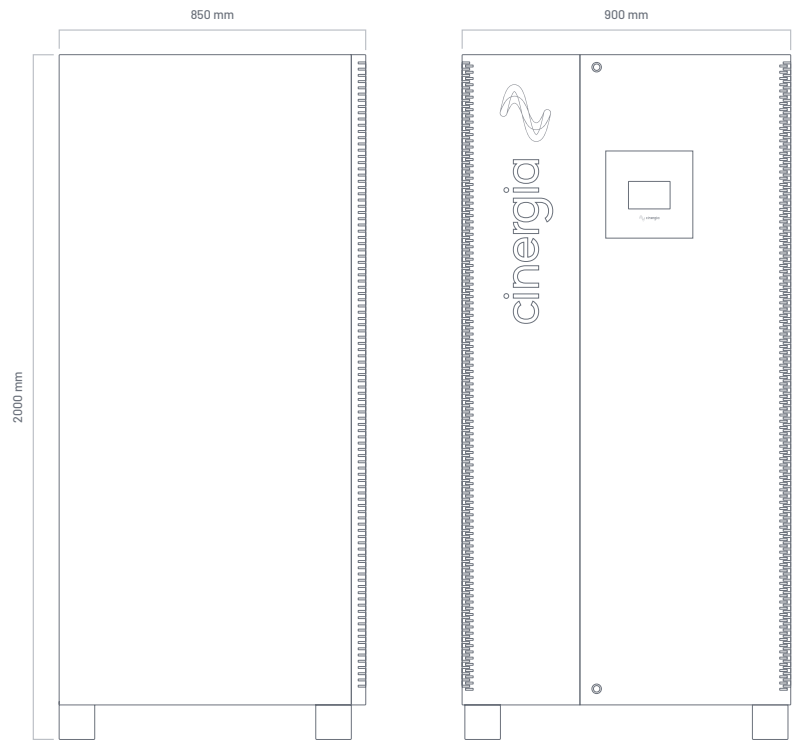

Connections

Fiber Optics

Digital IO

EPO EPO Output

Analogue IO

Internal Comms

Modbus

CAN Out

RS323 / RS485

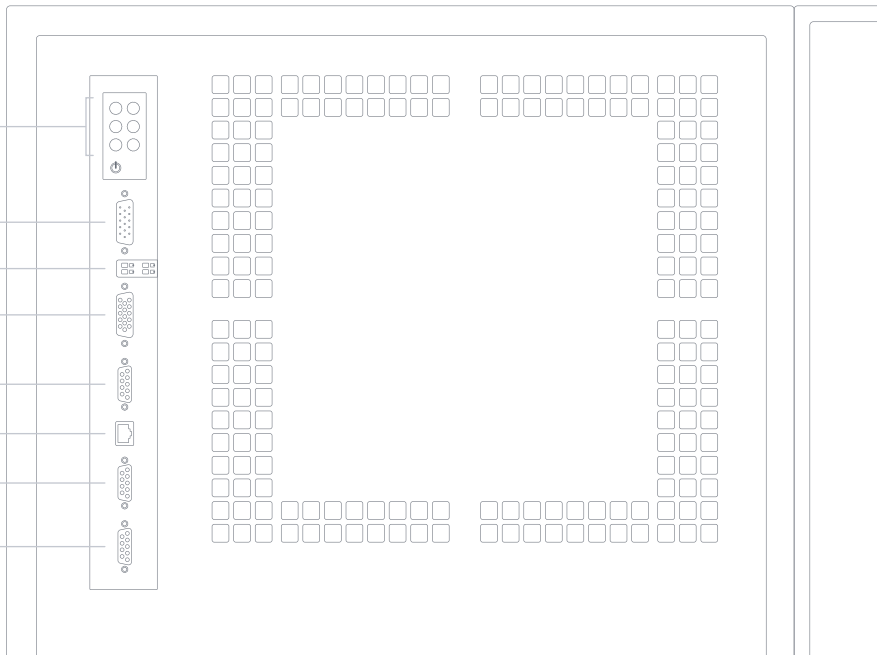

The distribution of the connectors may change depending on the models

Selectors

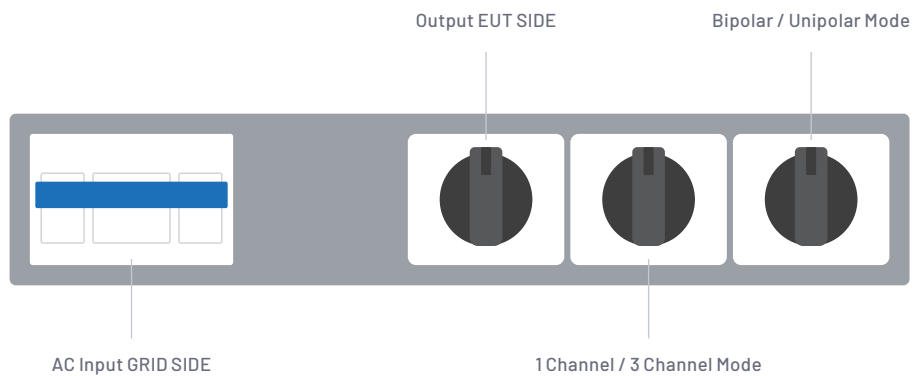

The type of selectors and their location may change depending on the models

Protections

Overvoltage (peak, rms), Overcurrent (peak, rms), Overload
Shortcircuit, Emergency Stop, Watchdog, Heart Beat, Output
Contactar, Wrong Configuration
Alarms and Limits are user configurable and can be saved in a
password protected EEPROM

Mesurements ⁽⁶⁾

Grid Voltage (rms), Current (rms), Power (P,O) and Frequency
Output Voltage (rms, avg), Current (rms, avg), Power (P,O) and Frequency
Heatsink Temperatures (x2) and DC Link Voltage
Datalogging available through FTP connection

Ambient

Operating temperature⁽⁸⁾: 5-40°C
Relative Humidity: up to 95%, non-condensing
Cooling: Forced air
Acoustic noise at 1m: < 52dB(A)(7.5 to 60), < 65dB(A)(80 to 120), < 70dB(A)(160 and 200)

Standards

CE Marking
Operation and Safety: EN-50178, EN-62040-1
EMC: EN-62040-2
RoHS

All specifications are subject to change without notice.

Options

Choose your options:

- Three channel mode: allows different operation mode start/stop/reset per channel (included in all models from 7.5 to 60, both included)
- 30kHz Switching Frequency: only available for models 15 (derated to 7.5kW), 20 (derated to 7.5kW) and 30 (derated to 10kW)
- Isolation monitor (advised for IT systems)
- Low voltage ripple capacitance
- Anti-islanding monitor (only advised in net injection to the grid and following local regulations)
- RS485
- Battery Emulation
- Battery Test
- PV Panel Emulation

All specifications are subject to change without notice.

1. Minimum voltage setpoint is 0V in DC. The recommended minimum setpoint for long-term use is 20Vrms in AC and 20V in DC.
2. Effective resolution measured with a 400ms window
3. FS Range of voltage is 830V (with High Voltage option)
FS Range of current is $2 \cdot |3 \cdot I_{rated}|$ (see models table)
FS Range of power is $2 \cdot |200\% \cdot P_{rated}|$ (see models table)
4. Accuracies are valid for settings above 10% of FS
5. Measured with the rated resistive load and high-dynamics controllers configuration.
6. Accuracy of measurements is $\pm 0.1\%$ of FS for rms voltage, $\pm 0.2\%$ of FS for rms current, $\pm 0.4\%$ of FS for active power (valid only above 10% of FS)
7. Consult us for lower voltage/current ripple requirements
8. Rated power figures are given at 20°C
9. The maximum output voltage depends on frequency following $V \cdot f < 46000$
10. With fast DC control behaviour

Models

B2C+

Reference	DC Power Rated ⁽⁹⁾	DC Voltage Range	DC Current Rated 3 channels Unipolar Mode	DC Current Rated 1 channel Unipolar Mode	DC Current Rated +/-/ Bipolar 4Q Mode	Weight (kg)	Dimensions DxWxH (mm)
B2C+7.5	7.5 kW	20 - 800 V	±10 A	±30 A	±10 A	155 kg	770 x 450 x 1100 mm
B2C+10	10 kW	20 - 800 V	±15 A	±45 A	±15 A	155 kg	770 x 450 x 1100 mm
B2C+15	15 kW	20 - 800 V	±20 A	±60 A	±20 A	155 kg	770 x 450 x 1100 mm
B2C+20	20 kW	20 - 800 V	±25 A	±75 A	±25 A	155 kg	770 x 450 x 1100 mm
B2C+30	27 kW	20 - 800 V	±30 A	±90 A	±30 A	155 kg	770 x 450 x 1100 mm
B2C+40	40 kW	20 - 800 V	±40 A	±120 A	±40 A	200 kg	770 x 450 x 1100 mm
B2C+50	50 kW	20 - 800 V	±50 A	±150 A	±50 A	200 kg	770 x 450 x 1100 mm
B2C+60	54 kW	20 - 800 V	±57 A	±171 A	±57 A	200 kg	770 x 450 x 1100 mm
B2C+80	80 kW	20 - 800 V	±105 A	±315 A	±105 A	320 kg	870 x 590 x 1320 mm
B2C+100	100 kW	20 - 800 V	±130 A	±390 A	±130 A	320 kg	870 x 590 x 1320 mm
B2C+120	108 kW	20 - 800 V	±130 A	±390 A	±130 A	320 kg	870 x 590 x 1320 mm
B2C+160	145 kW	20 - 800 V	±155 A	±465 A	±155 A	680 kg	850 x 900 x 2000 mm
B2C+200	160 kW	20 - 800 V	±185 A	±555 A	±185 A	680 kg	850 x 900 x 2000 mm

All specifications are subject to change without notice.

Galvanic Isolation

	Circuit Breaker Recommended	Weight	
Inside the cabinet	IT 7.5i	Type C - 25 A	145 kg
	IT 10i	Type C - 25 A	145 kg
	IT 15i	Type C - 32 A	145 kg
	IT 20i	Type C - 40 A	145 kg
	IT 30i	Type C - 50 A	195 kg
	IT 40i*	Type C - 63 A	195 kg
	IT 50i*	Type C - 83 A	195 kg

*In the IT 40i and IT 50i models the size of the cabinet increases to a total of 770 x 835 x 1100 mm. The others keep the original size.

	Circuit Breaker Recommended	Weight	Dimensions D x W x H	
In external cabinet IP20	IT 30e	Type D - 80 A	174 kg	595 x 415 x 708 mm
	IT 40e	Type D - 100 A	217 kg	725 x 525 x 773 mm
	IT 50e	Type D - 125 A	280 kg	725 x 525 x 773 mm
	IT 60e	Type D - 160 A	381 kg	875 x 600 x 900 mm
	IT 80e	Type D - 200 A	435 kg	875 x 600 x 900 mm
	IT 100e	Type D - 250 A	458 kg	875 x 600 x 900 mm
	IT 120e	Type D - 315 A	514 kg	875 x 600 x 900 mm
	IT 160e	Type D - 400 A	612 kg	964 x 648 x 1252 mm
IT 200e	Type D - 500 A	753 kg	1192 x 744 x 1430 mm	

Configuration Modes

DC	PHIL DC
----	---------

Master / Slave

Parallel	Serial	Serial Parallel	in DC mode
----------	--------	-----------------	------------

Channel Configuration in DC

3 channels	1 channel	Bipolar	Unipolar
------------	-----------	---------	----------

Regenerative Power Electronic Solutions



Can Baletes 7, Nau A
08310 Argentona
Barcelona (Spain)
+34 934 864 358
cinergia@ciner giapower.com

Follow us on:
Youtube, LinkedIn, Twitter